

Don R. Wallick Auctions, Inc.

965 N. Wooster Avenue - Strasburg, Ohio 44680 - www.WallickAuctions.com
Toll Free: 1-866-348-9446 - Tel: 330-878-0075 - Fax: 330-878-7318

Auction







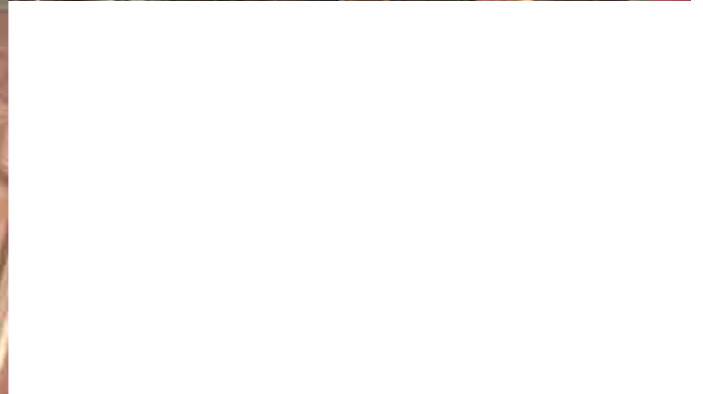



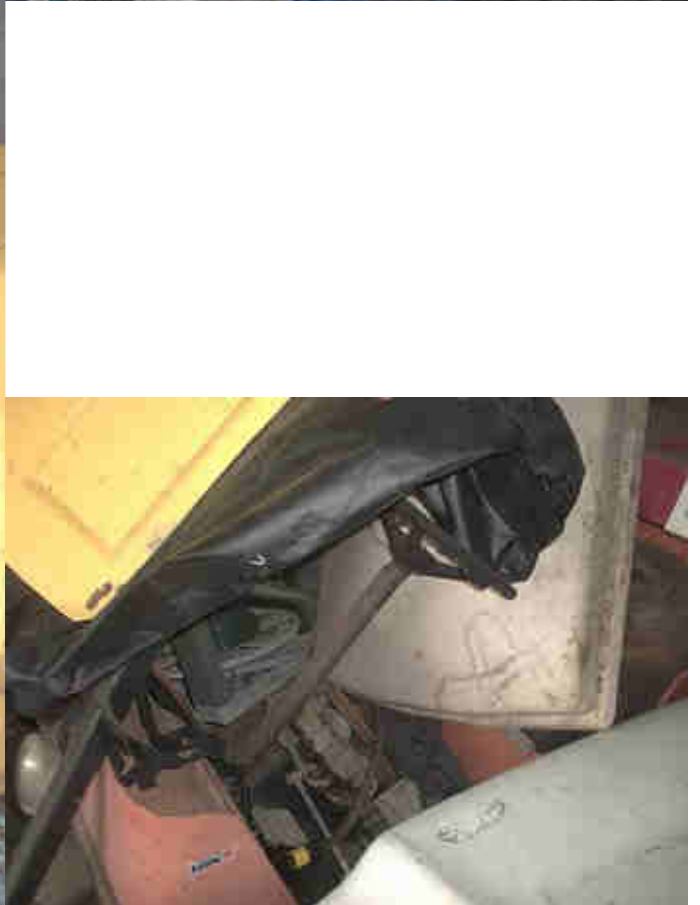

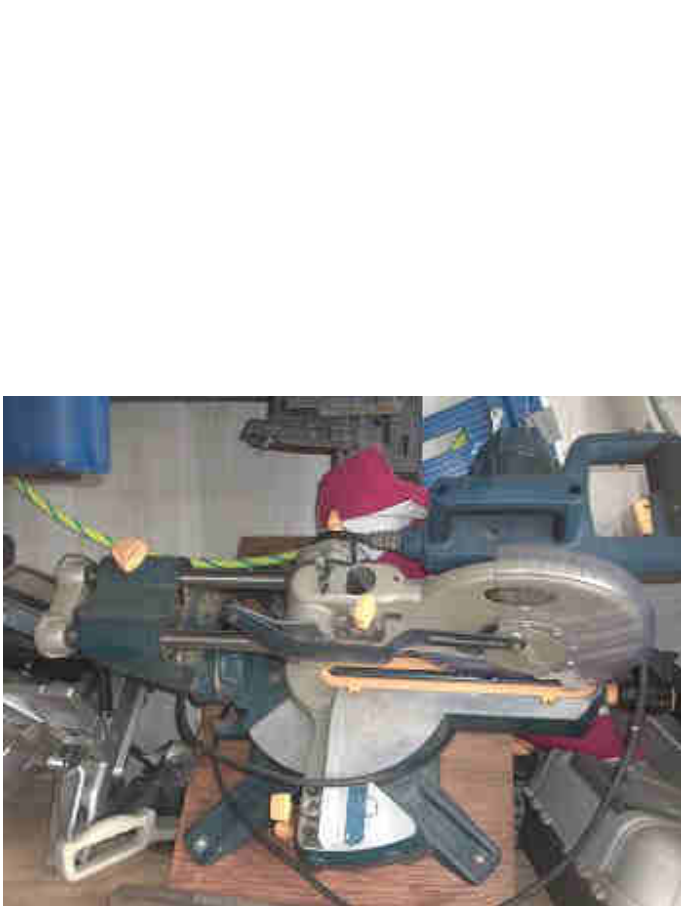

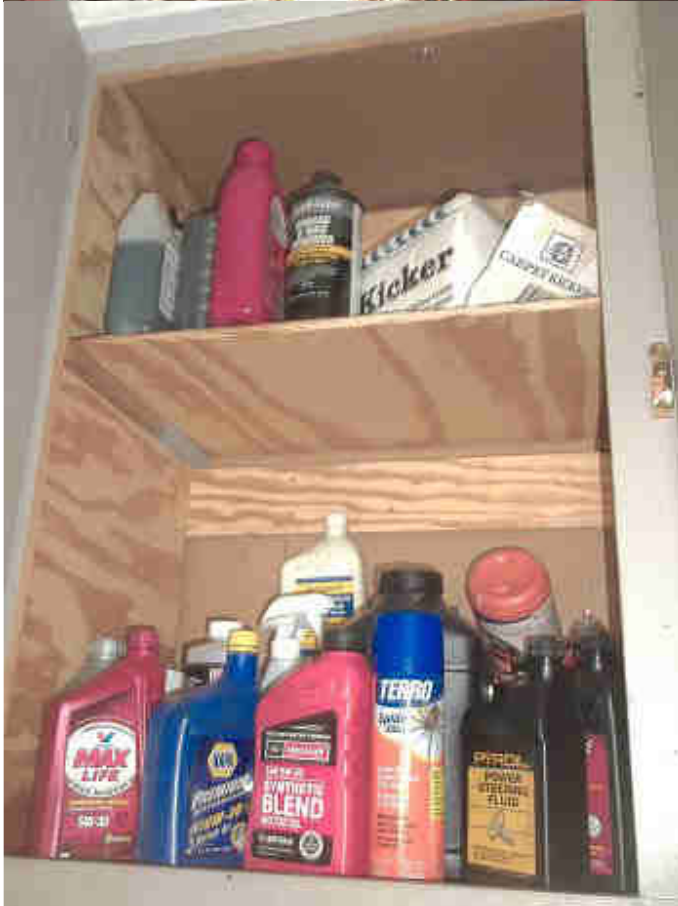
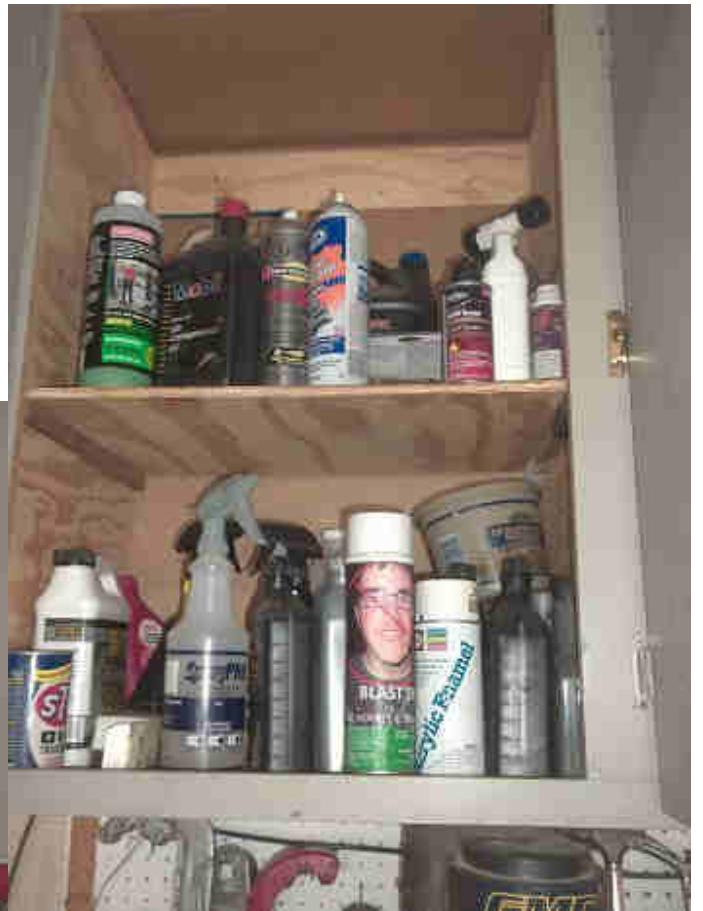



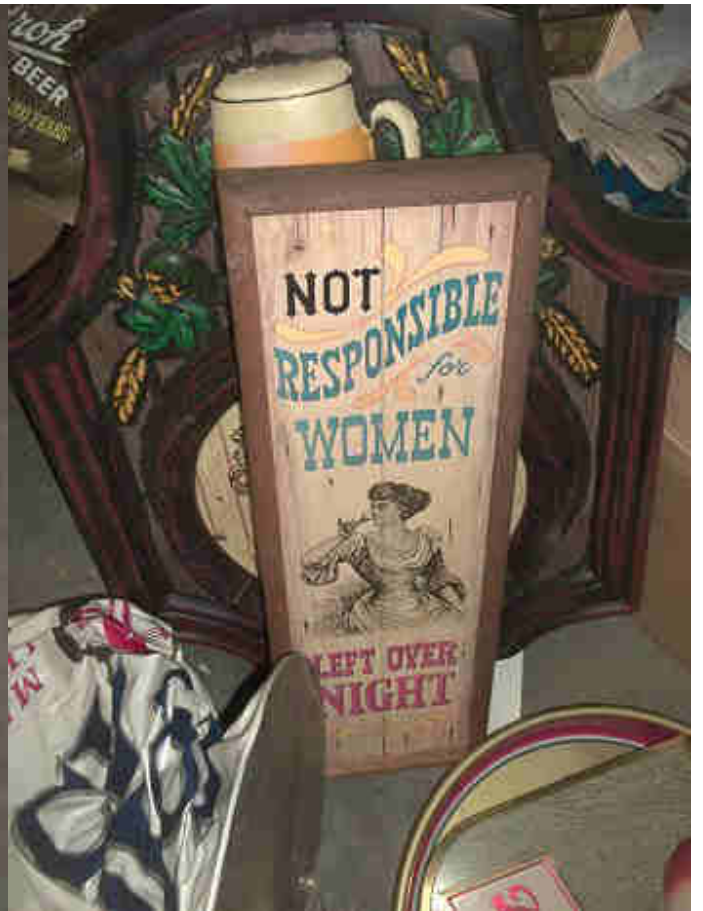

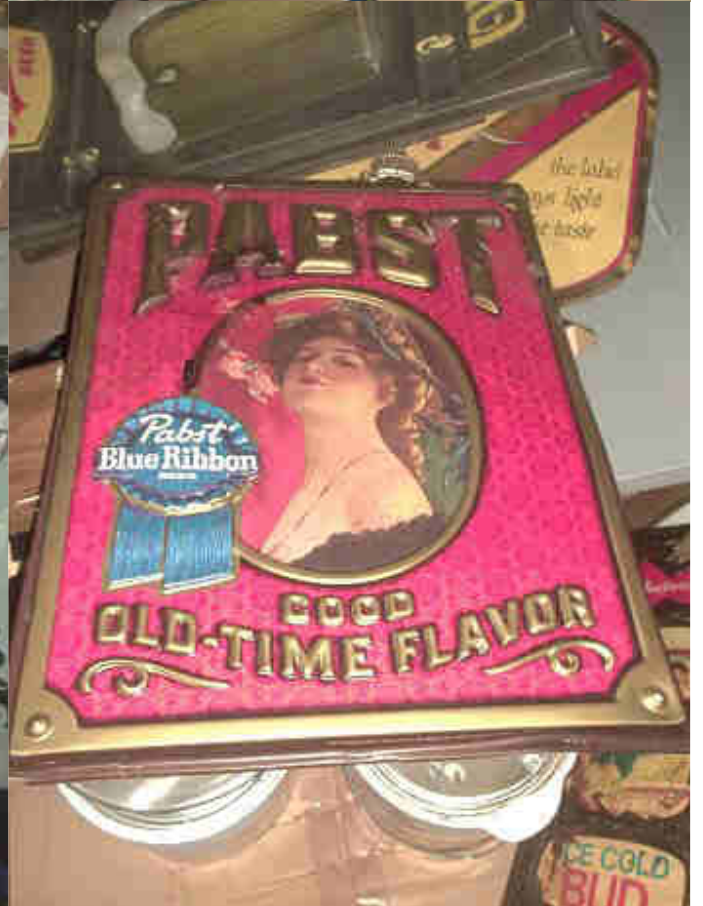

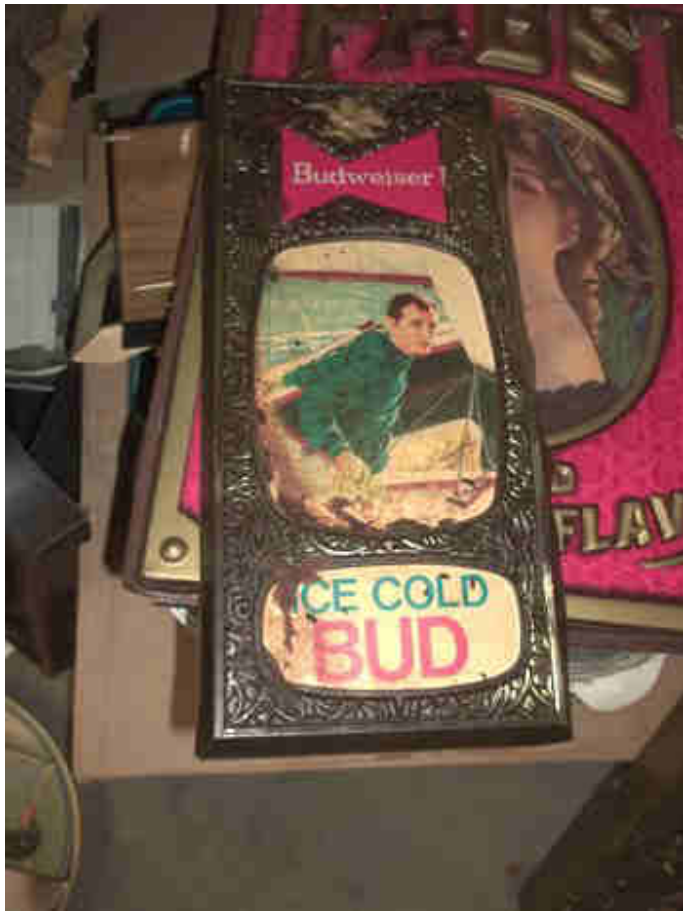





Assembly by Key No. for 14x21 Building

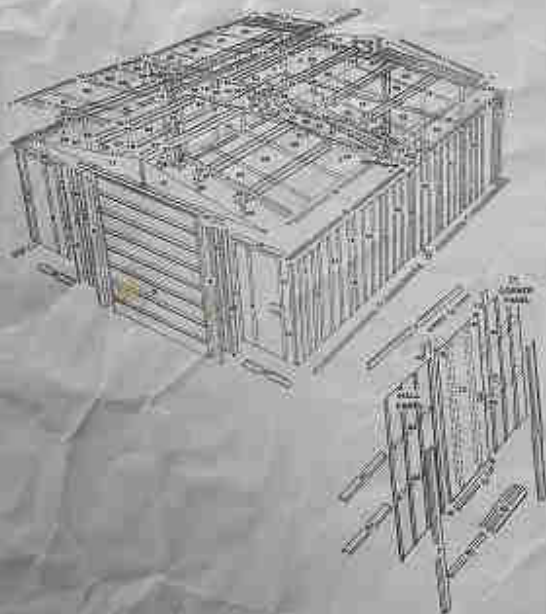

Assembly by Key No. & 14' x 31' Building

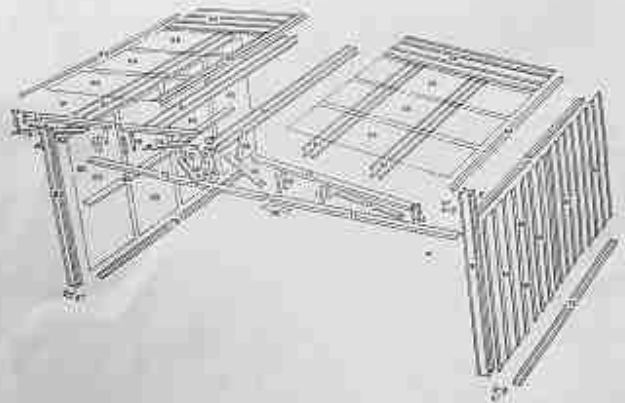

Step 21

Parts Needed For Roof Panels/Ridge Caps

- 100' Roll Roof Panel (1)
- 100' Roll Ridge Cap (2)
- 100' Roll Ridge Cap (3)

- 1 Install 2 more roof panels.
- 2 Install the first ridge cap on each end of the second ridge cap location. To properly remove the roll cover roof panels, first install the remaining 2 roof panels. To do this, lay over the roll cover with weather strip over head of roof.
- 3 Install the cover roof panels. Fasten ridge cap using bolts and nuts.
- 4 Custom the lower end of the panels to the 50C base channels using screws and washers.
- 5 Lay the first ridge cap over roof panels.
- 6 Install the second ridge cap including the second ridge cap as before. Install 100' roll roof panels under the second ridge cap and cover with weather strip over head of roof. Fasten ridge cap using bolts and nuts.
- 7 Install 100' roll panels on the second ridge cap. Temporarily remove the roll cover roof panels, and install the remaining 2 roof panels. Fasten the top weather strip cover with weather strip over head of roof.
- 8 Install the cover roof panels. Fasten ridge cap using bolts and nuts.
- 9 Fasten the lower end of the panels to the 50C base channels using screws and washers.

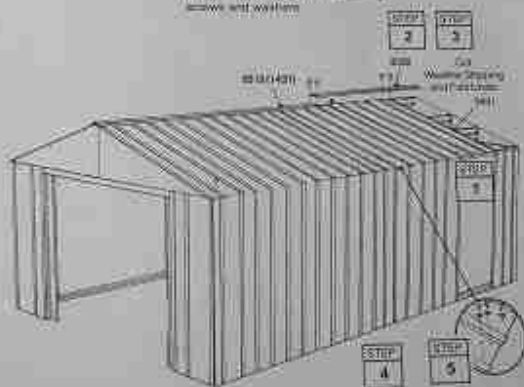

Step 22

Parts Needed For Roof Trim

- 100' Roll Roof Panel (1)
- 100' Roll Ridge Cap (2)
- 100' Roll Ridge Cap (3)

- 1 Install the side roof trim to the three ends of the roof panels on each side of the building using screws to each panel overlap.
- 2 Position left and right roof trim to the ends of roof, fitting the trim into under-ridge cap, but to the top of side rooming.
- 3 Fasten roof panel rib trim, peak cap and ridge cap together using bolts and nuts. Fasten the remaining peak cap at the same manner.
- 4 Lay 100' roll roof panels from overtop of the second ridge cap to the side roof trim. At the corner install weather strip on the right and left roof trim cap if one right and left corner.
- 5 Fasten trim to side trim using a screw and washer into roof panel.
- 6 Fasten the roof trim to each side of trim using a screw.

NOTE
A single screw fastens both the panels at the overlap.

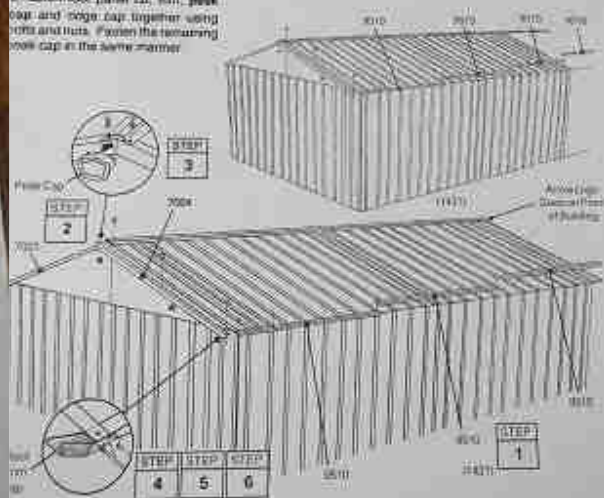



Step 22

Parts Needed For Roof Trim

- 1000 1/2" x 1/2" x 1/2" (100)
- 1000 1/2" x 1/2" x 1/2" (100)
- 1000 1/2" x 1/2" x 1/2" (100)

1. Place the side roof trim in the level channel for each panel on each side of the building using arrows of each panel pointing.
2. Position left and right roof trim in the ends of roof, perpendicular from edge under ridge cap, in the area of side rafters.
3. Fasten roof panel to side peak cap and ridge cap together using 1000 and nuts. Fasten the remaining peak cap in the same manner.
4. Using your thumb and index finger, push the bottom flange of the side roof trim at the corner inward enough so the adjacent left hand side peak cap will fit over it.
5. Repeat this on both roof panels on other and water side of building.
6. Connect roof trim to side rafters using a nut.

NOTE:
A single screw fastener holds two pieces of the trim.

Parts List

Part No.	Description	Quantity
1000	1/2" x 1/2" x 1/2"	100
1001	1/2" x 1/2" x 1/2"	100
1002	1/2" x 1/2" x 1/2"	100
1003	1/2" x 1/2" x 1/2"	100
1004	1/2" x 1/2" x 1/2"	100
1005	1/2" x 1/2" x 1/2"	100
1006	1/2" x 1/2" x 1/2"	100
1007	1/2" x 1/2" x 1/2"	100
1008	1/2" x 1/2" x 1/2"	100
1009	1/2" x 1/2" x 1/2"	100
1010	1/2" x 1/2" x 1/2"	100
1011	1/2" x 1/2" x 1/2"	100
1012	1/2" x 1/2" x 1/2"	100
1013	1/2" x 1/2" x 1/2"	100
1014	1/2" x 1/2" x 1/2"	100
1015	1/2" x 1/2" x 1/2"	100
1016	1/2" x 1/2" x 1/2"	100
1017	1/2" x 1/2" x 1/2"	100
1018	1/2" x 1/2" x 1/2"	100
1019	1/2" x 1/2" x 1/2"	100
1020	1/2" x 1/2" x 1/2"	100
1021	1/2" x 1/2" x 1/2"	100
1022	1/2" x 1/2" x 1/2"	100
1023	1/2" x 1/2" x 1/2"	100
1024	1/2" x 1/2" x 1/2"	100
1025	1/2" x 1/2" x 1/2"	100
1026	1/2" x 1/2" x 1/2"	100
1027	1/2" x 1/2" x 1/2"	100
1028	1/2" x 1/2" x 1/2"	100
1029	1/2" x 1/2" x 1/2"	100
1030	1/2" x 1/2" x 1/2"	100
1031	1/2" x 1/2" x 1/2"	100
1032	1/2" x 1/2" x 1/2"	100
1033	1/2" x 1/2" x 1/2"	100
1034	1/2" x 1/2" x 1/2"	100
1035	1/2" x 1/2" x 1/2"	100
1036	1/2" x 1/2" x 1/2"	100
1037	1/2" x 1/2" x 1/2"	100
1038	1/2" x 1/2" x 1/2"	100
1039	1/2" x 1/2" x 1/2"	100
1040	1/2" x 1/2" x 1/2"	100
1041	1/2" x 1/2" x 1/2"	100
1042	1/2" x 1/2" x 1/2"	100
1043	1/2" x 1/2" x 1/2"	100
1044	1/2" x 1/2" x 1/2"	100
1045	1/2" x 1/2" x 1/2"	100
1046	1/2" x 1/2" x 1/2"	100
1047	1/2" x 1/2" x 1/2"	100
1048	1/2" x 1/2" x 1/2"	100
1049	1/2" x 1/2" x 1/2"	100
1050	1/2" x 1/2" x 1/2"	100
1051	1/2" x 1/2" x 1/2"	100
1052	1/2" x 1/2" x 1/2"	100
1053	1/2" x 1/2" x 1/2"	100
1054	1/2" x 1/2" x 1/2"	100
1055	1/2" x 1/2" x 1/2"	100
1056	1/2" x 1/2" x 1/2"	100
1057	1/2" x 1/2" x 1/2"	100
1058	1/2" x 1/2" x 1/2"	100
1059	1/2" x 1/2" x 1/2"	100
1060	1/2" x 1/2" x 1/2"	100
1061	1/2" x 1/2" x 1/2"	100
1062	1/2" x 1/2" x 1/2"	100
1063	1/2" x 1/2" x 1/2"	100
1064	1/2" x 1/2" x 1/2"	100
1065	1/2" x 1/2" x 1/2"	100
1066	1/2" x 1/2" x 1/2"	100
1067	1/2" x 1/2" x 1/2"	100
1068	1/2" x 1/2" x 1/2"	100
1069	1/2" x 1/2" x 1/2"	100
1070	1/2" x 1/2" x 1/2"	100
1071	1/2" x 1/2" x 1/2"	100
1072	1/2" x 1/2" x 1/2"	100
1073	1/2" x 1/2" x 1/2"	100
1074	1/2" x 1/2" x 1/2"	100
1075	1/2" x 1/2" x 1/2"	100
1076	1/2" x 1/2" x 1/2"	100
1077	1/2" x 1/2" x 1/2"	100
1078	1/2" x 1/2" x 1/2"	100
1079	1/2" x 1/2" x 1/2"	100
1080	1/2" x 1/2" x 1/2"	100
1081	1/2" x 1/2" x 1/2"	100
1082	1/2" x 1/2" x 1/2"	100
1083	1/2" x 1/2" x 1/2"	100
1084	1/2" x 1/2" x 1/2"	100
1085	1/2" x 1/2" x 1/2"	100
1086	1/2" x 1/2" x 1/2"	100
1087	1/2" x 1/2" x 1/2"	100
1088	1/2" x 1/2" x 1/2"	100
1089	1/2" x 1/2" x 1/2"	100
1090	1/2" x 1/2" x 1/2"	100
1091	1/2" x 1/2" x 1/2"	100
1092	1/2" x 1/2" x 1/2"	100
1093	1/2" x 1/2" x 1/2"	100
1094	1/2" x 1/2" x 1/2"	100
1095	1/2" x 1/2" x 1/2"	100
1096	1/2" x 1/2" x 1/2"	100
1097	1/2" x 1/2" x 1/2"	100
1098	1/2" x 1/2" x 1/2"	100
1099	1/2" x 1/2" x 1/2"	100
1100	1/2" x 1/2" x 1/2"	100

Auction Conducted By:
 Don R. Wallick Auctions, Inc.
 Auctioneers: Don R. Wallick

Brennan R. Wallick
Ryan W. Wallick

Don R. Wallick Auctions, Inc.
965 N. Wooster Avenue
Strasburg, Ohio 44680
info@WallickAuctions.com
<http://www.WallickAuctions.com>



Toll Free: 1-866-348-9446 - Tel: 330-878-0075 - Fax: 330-878-7318